

OWNERS MANUAL

InPower Model ITM131 Platform Lift Interlock 2006 - 2007 Chevy & GMC Vehicles

Contents

1. Introduction	1
2. Product Description	1
3. Installation Procedures	1
4. System and Circuit Diagrams	2
5. Wiring Instructions	5
6. Interlock System Operation.....	7
7. System Troubleshooting	7
8. Mechanical Drawings.....	8
9. Reference Information	8

1. Introduction

This product is intended for installation in 2006 - 2007 GM (Chevy & GMC) GMT610 van or C4500/C5500 chassis with FMVSS compliant, public use (commercial) platform lifts manufactured by The Braun Corporation, Ricon Corporation or Maxon Mobility. If another type of lift is to be used, contact the lift manufacturer to determine its compatibility.

The ITM131 interlock system is designed to meet the requirements of FMVSS 403/404 and therefore must be installed in accordance with the lift manufacturer's instructions. The installer must be trained and skilled in installing FMVSS compliant lift systems. The installation must also comply with SAE (Society of Automotive Engineers) and GM electrical wiring procedures.

2. Product Description

The ITM131 interlock system consists of a control module, optional remote driver's LED display, and chassis interface wiring harness. The control module is a solid state, non-microprocessor-based control device. It contains two connectors for interfacing to the remote LED display and wiring harness. It also contains six diagnostic LED indicators to aid in system troubleshooting. The "plug and play" GM chassis harness contains two tee-cables that connect to the parking brake switch and shift lock solenoid that are both located under the dash. Two harnesses are available, one for the van chassis and one for the C4500 & C5500 chassis. A set of nine 1/4 inch male Faston blade terminals are provided for interface to the platform lift system, door switch, transmission Park switch, +12 volt power and ground. There is also a door output that can be used to power an indicator light to show when the lift door is ajar/open. As the C4500 & C5500 chassis are not factory equipped with a shift lock solenoid a kit is offered by InPower that includes a solenoid and mounting bracket.

3. Installation Procedures

3.1 Safety Precautions



WARNING

This interlock product has been designed and manufactured to meet the intended application requirements and specifications. Any modifications to the product or to the installation procedure can be dangerous and will void InPower's warranty.

- Read and understand the instructions in this manual and other manuals before starting the installation.
- Make sure that the vehicle battery power is disconnected during installation of the Interlock and lift systems.
- Reconnect the battery when the system installation is complete.
- Wear appropriate safety equipment, such as protective eyeglasses, face shield and clothing when installing equipment and handling the battery.
- Be careful when working near a battery. Make sure that the area is well ventilated and that there are no flames near the battery. Never lay objects on the battery that can short the terminals together. If battery acid gets in your eyes, immediately seek first aid. If acid gets on your skin, immediately wash it off with soap and water.

3.2 Getting Started

This manual provides instructions for installing the InPower Model ITM131 Interlock System in a 2006 - 2007 GM van or C4500/C5500 chassis with a FMVSS compliant, public use (commercial) platform lift. It is important that you follow these instructions carefully and contact InPower if you need assistance or more information. Note that product technical documents are available on InPower's web site.



WARNING

Before installing and operating this interlock system, read and understand the lift manufacturer's safety, operating and installation instructions.

This interlock system installation requires additional parts and materials that are not supplied with the interlock product (See Section 9.2). Identify all required parts before starting the installation and ensure that these items are the correct type and quality.

Inspect the interlock product and all other components for damage before starting the installation. Do not perform the installation if any problems exist.

Determine the type of interlock interface required for the platform lift. This interlock system provides a +12 volt @ 10 amps *Lift Enable* output to allow the platform lift to be operated. It also requires a *Lift Stowed* signal from the lift system that is at ground when the lift is in the fully stowed position. If the lift system is not compatible with these two interface signals you must take the necessary actions to adapt the lift system interface to the interlock system's interface. Refer to the lift manufacturer's installation instructions for further details.

The recommended mounting location for the ITM131 interlock module is under the dash, to the left of the steering column due to the proximity of the wiring connections. **The unit must not be located in the engine compartment or any location that is not protected from the environment.**

4. System and Circuit Diagrams

The following pages show the individual circuits that need to be wired. The following section, 5. Installation Instructions, describes how to wire these circuits.

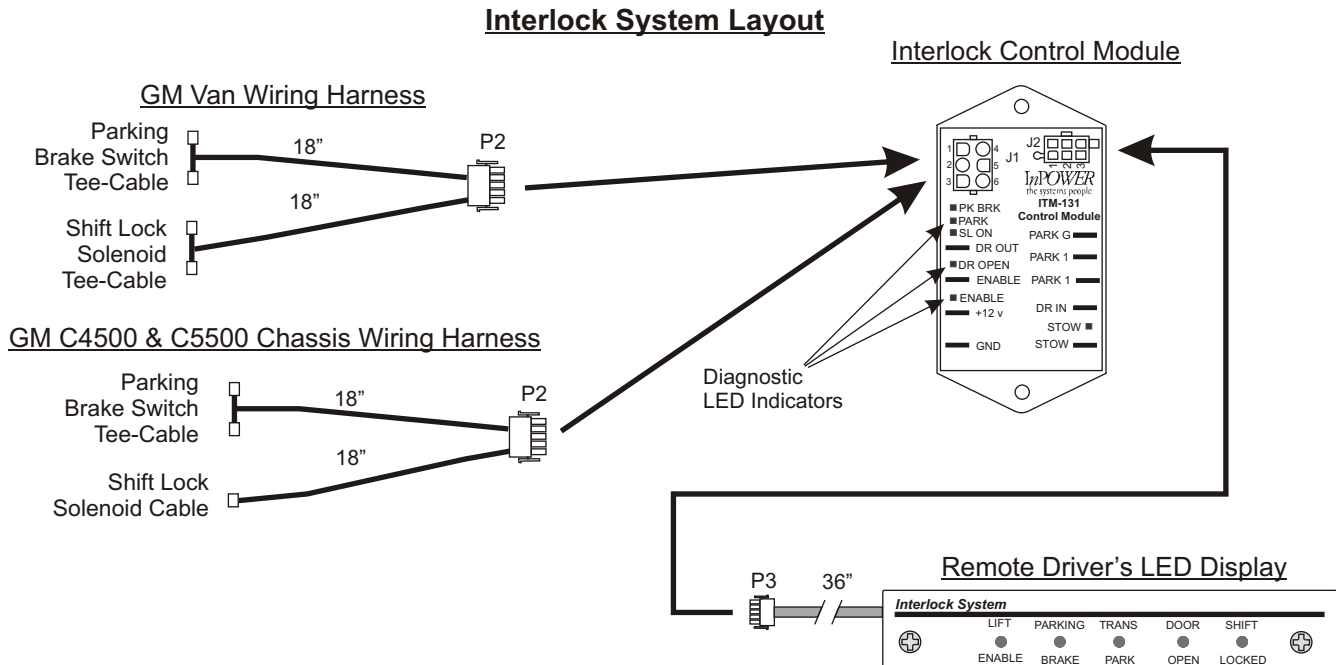

**InPOWER ITM-131
Interlock Module**

J2

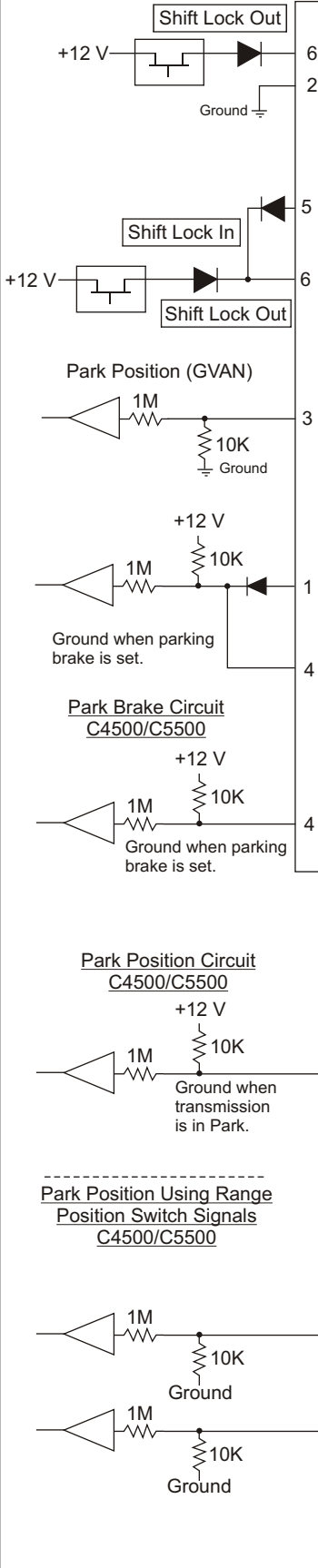

CIRCUIT 1A - Shift Lock Solenoid Cable (C4500/C5500 Chassis)

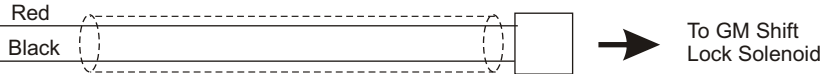

CIRCUIT 1B - Shift Lock Solenoid Cable (Van Chassis)

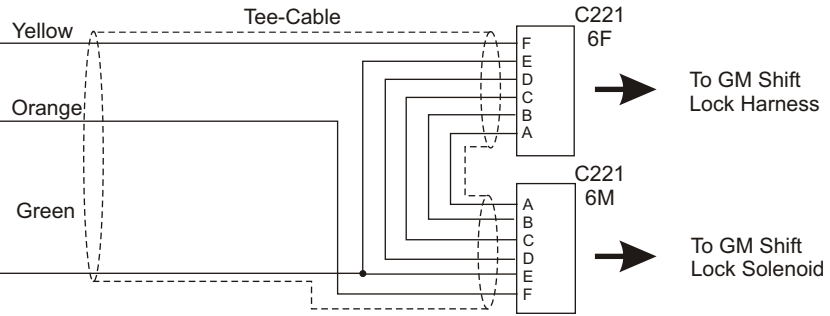

CIRCUIT 2A - Parking Brake Cable (Van Chassis)

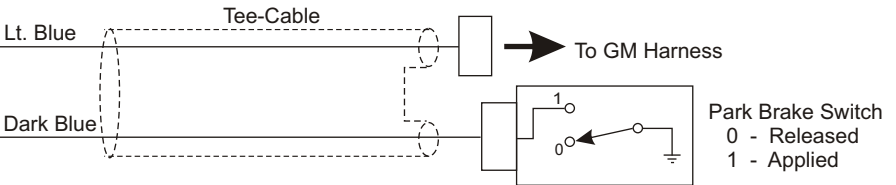

CIRCUIT 2B - Parking Brake Cable (C4500 & C5500 Chassis)

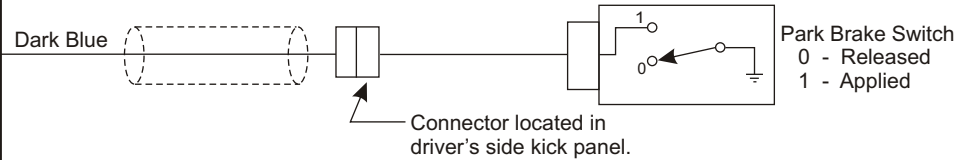

CIRCUIT 3A - Park Position (C4500 & C5500 Chassis)

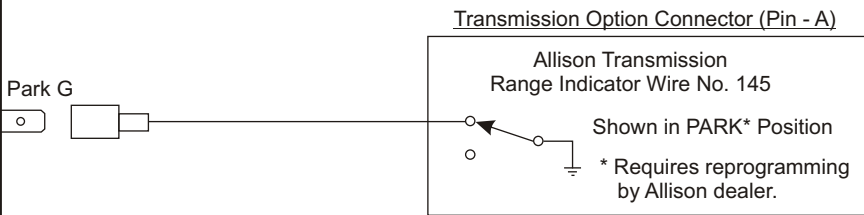

CIRCUIT 3B - Park Position (C4500 & C5500 Chassis)

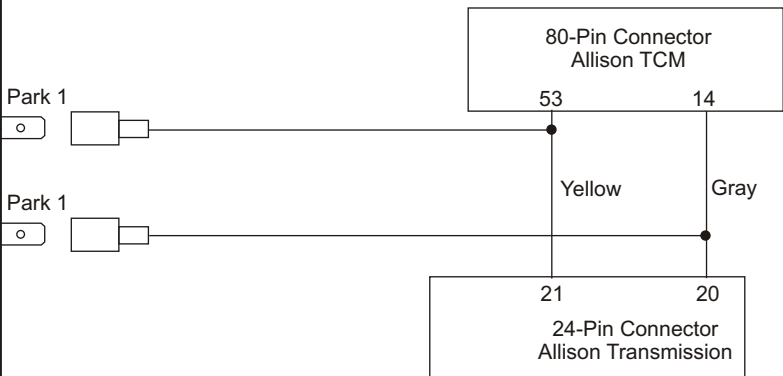

**InPOWER ITM-131
Interlock Module**

CIRCUIT 4 - Lift Door Switch & Lamp

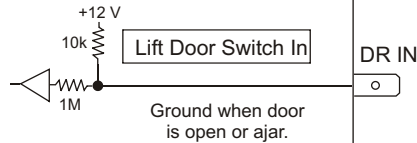

Ground when door is open or ajar.

DR IN

Connect this wire to either of the circuits to the right, depending on the chassis type, or to a user-installed door switch.

GMT 610 GVAN Rear Door

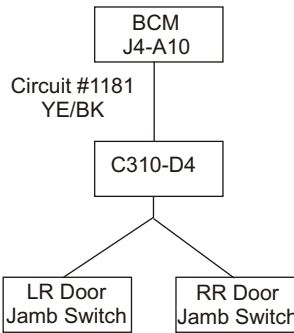

GMT 610 GVAN Side Door

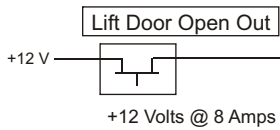
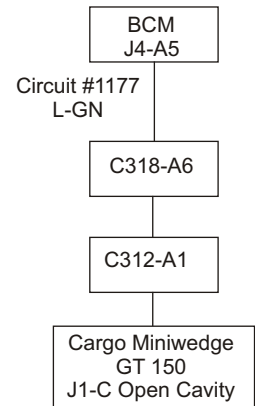

Lift Door Open/Ajar

CIRCUIT 5 - Power Switch

Interlock Power Switch (Not supplied with the Interlock system)

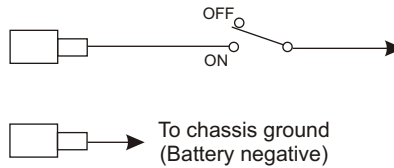
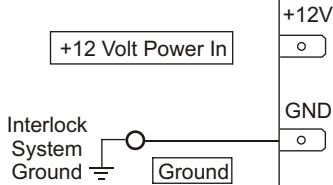

**Ignition +12 Volts (This must be +12 Volts only when Ignition Switch is on)
Note - This must be properly fused.**

CIRCUIT 6 - Platform Lift System

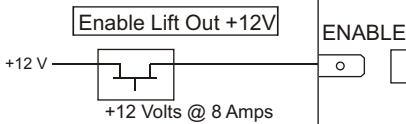

ENABLE

Lift Control System
(+12 Volts to allow operation of platform lift)

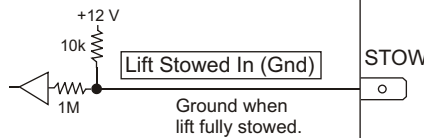

STOW

Lift Stowed Signal
Ground when lift is in fully stowed position)

NOTE - Refer to lift system documentation for wiring connections.

J3

36 inches

Remote Driver's LED Display

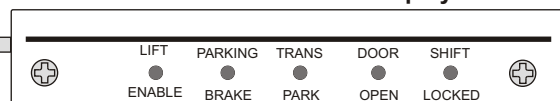

5. Wiring Instructions



WARNING

Make sure that the vehicle battery power is disconnected during installation of the Interlock and lift system. Reconnect the battery when the system installation is complete.

Circuit 1A - Shift Lock Solenoid Cable (Purchased Separately for C4500 & C5500 Chassis)

1. Install the InPower shift lock solenoid kit per instruction supplied with the kit.
2. Install the *GM C4500 & C5500 Wiring Harness* supplied with the interlock system. Plug one end into J2 on the interlock control module and the cable with the single connector into the shift lock solenoid as shown in Circuit Diagram 1A.

Circuit 1B - Shift Lock Solenoid Cable (GVans)

1. Locate the 6-pin inline connector C221 brake switch harness to L/P harness.
2. Connect the GVAN tee-cable harness between these mating connectors.
3. Refer to Circuit #1B Drawing and GM document #888457.

Circuit 2A Parking Brake Switch Cable (GVans)

1. Locate the 2-pin inline connector C220 next to the parking brake. This 2-pin connector will have only one wire installed.
2. Connect the GVAN parking brake tee-cable harness between these two connectors.
3. Refer to Circuit #2A Diagram and GM document #888451.

Circuit 2B Parking Brake Switch Cable (C4500 & C5500 Chassis)

1. Locate the unused parking brake switch connector behind the left front kick panel.
2. Connect the interlock harness with the single wire to the unused connector located in the driver's-side kick panel. This white connector has a single blue wire and is connected to the parking brake switch located in the center of the cab.
3. Refer to Circuit # 2B Diagram and GM document #1017350.

Circuit 3A - Park Position (C4500 & C5500 Chassis)

Note - This method requires interfacing to the Allison Range Indicator option connector, and this requires having an Allison dealer reprogram the transmission to have this output set only in the Park position. (The normal program is for Park or Neutral.)

1. Install a wire between the interlock PARK G terminal and the Transmission Option Connector Pin-A.
2. Refer to Circuit Diagram # 3A.

Circuit 3B - Park Position (C4500 & C5500 Chassis)

Note - This method requires wiring into the Allison transmission harness to connect to two range sensor signals.

1. Determine the best location to splice into the two wires shown in Circuit Diagram # 3A.
2. Install a wire between one of the PARK 1 terminals on the interlock module and the wire running between the 80-pin Allison TCM connector (Pin-53) and the transmission 24 pin connector (Pin-21).
3. Install a wire between the other PARK 1 terminal on the interlock module and the wire running between the 80-pin Allison TCM connector (Pin-14) and the transmission 24 pin connector (Pin-20).
4. When complete the wiring should be as shown in Circuit #3B).

Circuit 4 Wiring (Lift Door Switch and Light)

1. For van installations you will need to locate the door switch wiring using Circuit #4 Diagram as a reference. When you have located the door switch wire in the GM harness install a wire between this wire and the DR IN terminal on the interlock module.
2. For installations on C4500 or C5500 chassis you will need to install a door switch and wire this switch so that when in the door open position a ground will be applied to the DR IN terminal on the interlock module.
3. If a door open light is required, wire the light to the DR OUT terminal on the interlock module as shown in the Circuit #4 Diagram.

5. Wiring Instructions (Continued)

Circuit 5 Wiring (Platform Lift)

- Review the platform lift installation manual and determine how to wire the ITM131 interlock to the following lift interface connections:
 - Enable Lift** - This is an **input** to the lift system. When at +12 volts, the platform lift can be operated. Install a wire from the platform lift's *Enable Lift* input to the ENABLE terminal on the interlock module.
Note - The ITM131 will supply a +12 volt @ 10 amp output to allow operation of the lift. Verify that this is the correct polarity for the platform lift.
 - Lift Stowed** - This is an **output** from the lift system. **Verify the polarity of this signal.** It should be a ground signal when the lift in the fully stowed position. Wire it to the STOW terminal on the interlock Module.

The following diagrams show the wiring interface of typical platform lift systems. **Be sure to verify the exact wiring interface for the lift system that you have.**

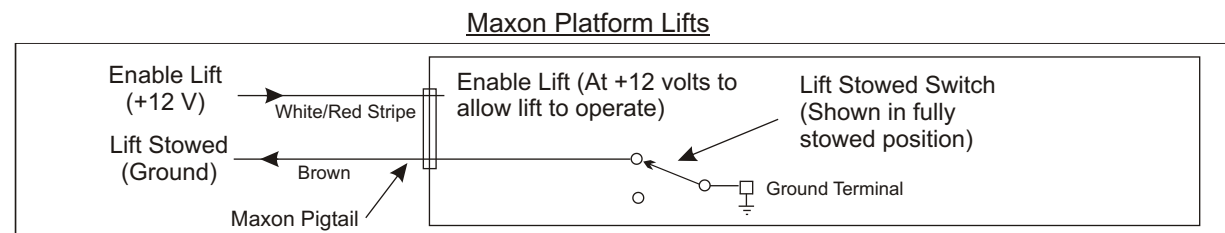
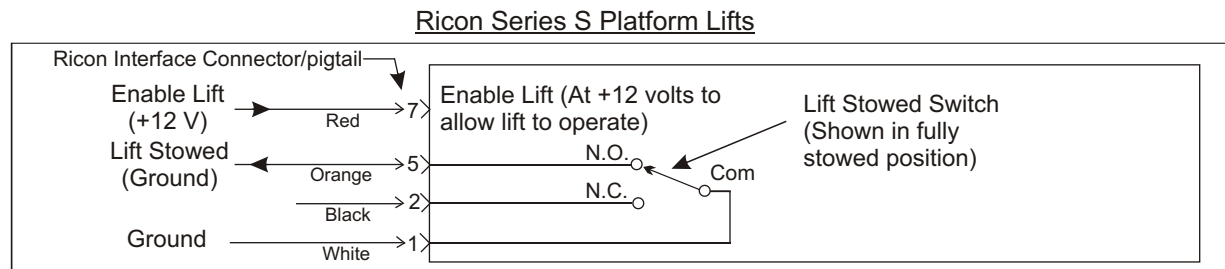
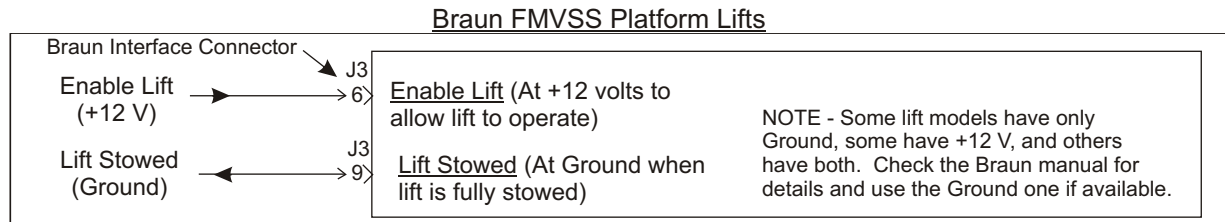

Circuit 5 Wiring (Interlock System Power Switch)

The installer must supply a two-position On-Off Interlock Power Switch. This switch may be mounted on the dash at a convenient location.

NOTE - An alternative method is to wire the interlock module power input directly to a +12 volt power source that is powered by the Ignition Switch, and delete the Interlock Power Switch.

- Mount the Interlock Power Switch.
- Wire the "common" side of the Power On/Off switch to a properly fused +12 volt fused ignition switch source (**powered when the ignition switch is On**). Refer to the GM documentation for location of customer access ignition circuits.
- Wire the "On" position side of the switch to the +12V terminal on the interlock module.
- When complete, you should have +12 volt fused power on the interlock module +12V terminal when the ignition switch is On and the Interlock Power Switch is On.

NOTE - Do not power the interlock system directly from the Battery or any power source that is not fused and turned off with the ignition switch.

- Install a wire from a good ground to the GND terminal on the interlock module.

5. Wiring Instructions (Continued)

Remote Driver's LED Display

The LED display includes a 36 inch cable that is attached to the underside of the display at one end and contains a 6-pin connector plug at the other end. Mount the display in a suitable location on the dash (usually to the right of the steering wheel). Two methods may be used for routing the cable. It may exit the side of the display so that it can be routed between the dash panel and the steering column. Or, you can drill a hole in the dash so that the cable can be routed through and behind the dash. Attach the display with the mounting screws provided, route the cable to the ITM116 control module, and insert the cable plug into connector J2.

NOTE - Consult GM documentation before drilling to verify the location of all critical components and harnesses.

6. Interlock System Operation

The interlock system is powered from the Interlock Power Switch and the Ignition Switch when they are both in the On position. The following is the interlock system sequence of operation:

- Step 1 - With the interlock powered on, place the transmission in the Park position.
- Step 2 - Set the parking brake.
- Step 3 - Open the lift door. When opened, the transmission shift lock will be set to prevent the transmission from being taken out of Park, and the Lift Enable will be set to allow operation of the platform lift. The Lift Door Open light, if installed, will operate.
- Step 4 - The platform lift may now be operated (Refer to the platform lift operating instructions). Note - During the Lift Enable sequence, if the parking brake is released the Lift Enable will be deactivated, preventing lift operation.
- Step 5 - When the lift cycle is completed return the lift to its fully stowed position.
- Step 6 - Close the lift door. Note - Depending on how the door switch is wired, all doors may need to be closed.
- Step 7 - Release the parking brake. When released, the shift lock will be automatically released.
- Step 8 - The cycle is now complete and the vehicle can be taken out of Park and driven.

Notes:

- 1. The Lift Door Open output (+12 v @ 10 amps) is activated whenever the door is open, independent of other interlock inputs.

7. System Troubleshooting

If there is a problem with system operation, there is a very high probability that the control module has: A) either lost its ground or +12 volt power source, or B) that one or more of its inputs are not being actuated by the remote sensor (e.g., Lift Door Switch or Lift Stowed Switch). Most troubles are related to wiring problems, or sensors either failing or becoming out of adjustment.

Troubleshooting Procedure:

- Step 1 - Determine if the control module is powered. If the LEDs on the control module are illuminated you have power. If none are illuminated, check the +12 volt supply on +12V terminal with a voltmeter. Also check that the module is getting a good ground on the GND terminal.
- Step 2 - If the ground and power are correct, first reset the interlock system by turning off its power. Then, step through the operating sequence as described in Section 6. *Interlock System Operation*, and note the status of the green and red LED indicators on the control module. Pay particular attention to the inputs (Green LEDs) such as the lift door switch input and the lift stowed switch input. Verify that the input status LEDs agree with the sensor positions.

The ITM131 interlock module contains six diagnostic LED indicators to aid in system troubleshooting. These indicators show the status of input and output signals of the ITM131 control module, and are color coded as follows: Input Signals = Green and Output Signals = Red. These diagnostic indicators are located on the connector side of the module.

7. System Troubleshooting (Cont'd)

System Diagnostic LED Indicators (Located on the Control Module)

- PARK (Green) On when the transmission is in the Park position.
- STOW (Green) On when the platform lift is the fully stowed position.
- DR OPEN (Green) On when the platform lift door is ajar or open (not fully closed).
- PK BRK (Green) On when the park brake is set.
- LIFT ENABLE (Red) On when the interlock allows the platform lift to operate.
- SL ON (Red) On when the interlock system is locking the shifter in the park position.

8. Mechanical Drawing

Model ITM131 Control Module

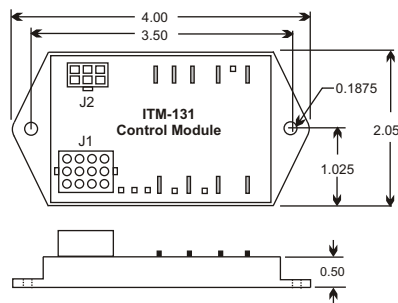

Driver's LED Display

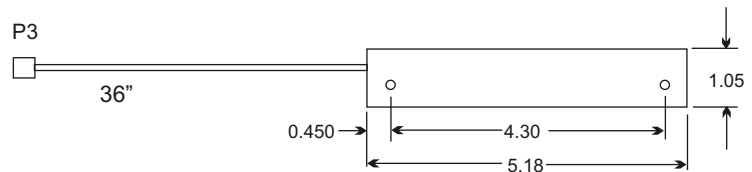

All dimensions in inches. Not to scale.

9. Reference Information

9.1 Company Contacts

GM Upfitter Integration

www.braunlift.com
Tel: 1-800-875-4742
Fax: 1-586-492-1085
www.gmupfitter.com

Ricon Corporation

7900 Nelson Road
Panorama City, CA 91402
(818) 267-3038
(800) 322-2884
www.riconcorp.com

The Braun Corporation

631 West 11th Street
Winamac, IN 46966
(574) 946-6153
(800) 946-6158
www.braunlifts.com

Maxon Lift Corp.

11921 Slauson Avenue
Sante Fe Springs, CA 90670
(562) 464-0099
(800) 227-4116
www.maxonlift.com

9.2 Required Parts Not Supplied with ITM131 Interlock

1. Power switch and fuse. See page 3, Circuit 3.
2. Lift Door Open indicator light, if required. See page 3, Circuit 4.
3. Lift Door Closed switch, if not using GM door switch. See page 3, Circuit 4.
4. Miscellaneous wire, mounting hardware, wire tie wraps, wire loom.